



eCATALOG
SOLUTIONS

CATALOGO ELETTRONICO DEI PRODOTTI

MOLTO PIU' DI SEMPLICI MODELLI CAD



Benvenuti da CADENAS Italiana s.r.l. Gruppo CADENAS

eCATALOG
SOLUTIONS

CATALOGO ELETTRONICO
DEI PRODOTTI

Azienda &
Logo



Fondata nel 1992
100 % di proprietà privata

La mia
persona



Giorgio Clari
Project Management Germania , Italia

Impiegati



~300 impiegati
in tutto il mondo

Mercati



Crescita > 12%
~ 450,000 Licenze e > 600 cataloghi



Collegamento tra i produttori di componenti e l'industria

CADENAS

SETTING STANDARDS

Produttori di componenti



➤ 600 cataloghi CAD nei settori della meccanica, elettronica, costruzione di impianti e macchinari, architettura navale industriale

Dei primi 25 cataloghi richiesti il 75% sono già in CADENAS

Industria



> 10.000 Aziende con
> 450.000 Utenti che utilizzano la gestione delle parti.

154 di queste aziende sono tra i primi 1000 Leader mondiali

CADENAS è visitato da 6.896.700 utenti web, vostri potenziali clienti.

CADENAS è usato anche nella progettazione e produzione di attrezzature ed utensili oltre che in ufficio vendite!



CADENAS – Il Partner giusto

eCATALOG
SOLUTIONS

CATALOGO ELETTRONICO
DEI PRODOTTI

18 Anni

STRACK®
NORMALIEN

11 Anni

FESTO

9 Anni

phd
SOLUZIONI PER BRUCIATORI E ALIMENTAZIONE

10 Anni

AHP MERKLE®
BEST

14 Anni

FIBRO

9 Anni

afag

13 Anni

Wipp

norelem

8 Anni

UNIVER®



CADENAS – Il Partner giusto

Settori che potete raggiungere con eCATALOGsolutions:

eCATALOG
SOLUTIONS

CATALOGO ELETTRONICO
DEI PRODOTTI





CADENAS – Il Partner giusto

Settori che potete raggiungere con eCATALOGsolutions:

eCATALOG
SOLUTIONS

CATALOGO ELETTRONICO
DEI PRODOTTI



INDUSTRIA NAVALE



INDUSTRIA AUTOMOBILISTICA

OEM



TIER1





CADENAS – Il Partner giusto

Settori che potete raggiungere con eCATALOGsolutions:

eCATALOG
SOLUTIONS

CATALOGO ELETTRONICO
DEI PRODOTTI

 **Costruzione Macchinari**



 **Imballaggi e Industria Alimentare**



 **Aeronautica**



 **Costruzione Impianti**





CADENAS – Il Partner giusto

Settori che potete raggiungere con eCATALOGsolutions:

eCATALOG
SOLUTIONS

CATALOGO ELETTRONICO
DEI PRODOTTI

 **MACCHINARI PER L'EDILIZIA**

		
---	---	--

 **ENERGIA**

			
---	---	--	---

 **ELETTRONICA**

					
---	---	--	---	---	---

 **MOTORI E INGRANAGGI**

			
---	---	--	---

 **MILITARE**

	
---	---





CADENAS – Il Partner giusto

Settori che potete raggiungere con eCATALOGsolutions:

eCATALOG
SOLUTIONS

CATALOGO ELETTRONICO
DEI PRODOTTI



Scegliereste un fornitore solo perché mette a disposizione i modelli CAD 3D pronti da scaricare?

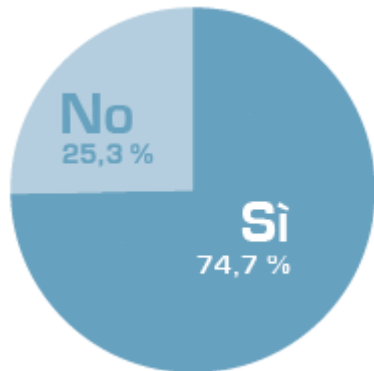

Quando scaricate un modello CAD 3D preferite che sia nel vostro formato CAD?

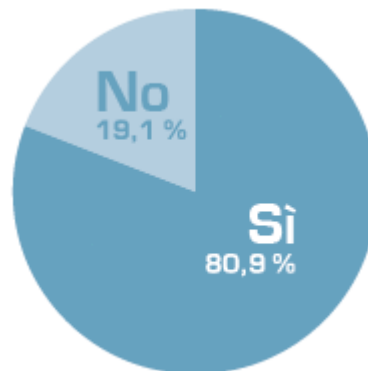

Quando scaricate un modello CAD 3D, il componente viene poi acquistato?

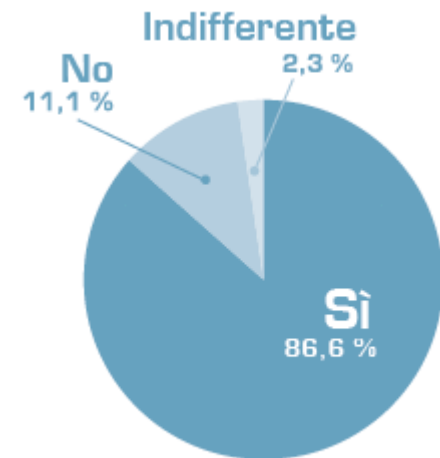

Con eCATALOGsolutions supportate al meglio gli ingegneri già durante la fase di progettazione.

Smart Parts

non deriva dalla grandezza ma dalla tecnologia!

eCATALOG
SOLUTIONS

CATALOGO ELETTRONICO
DEI PRODOTTI

„Tecnologia dell'ultimo millennio,
moltissimi di questi prodotti vengono
offerti ancora sul mercato“

Smart Part by CADENAS

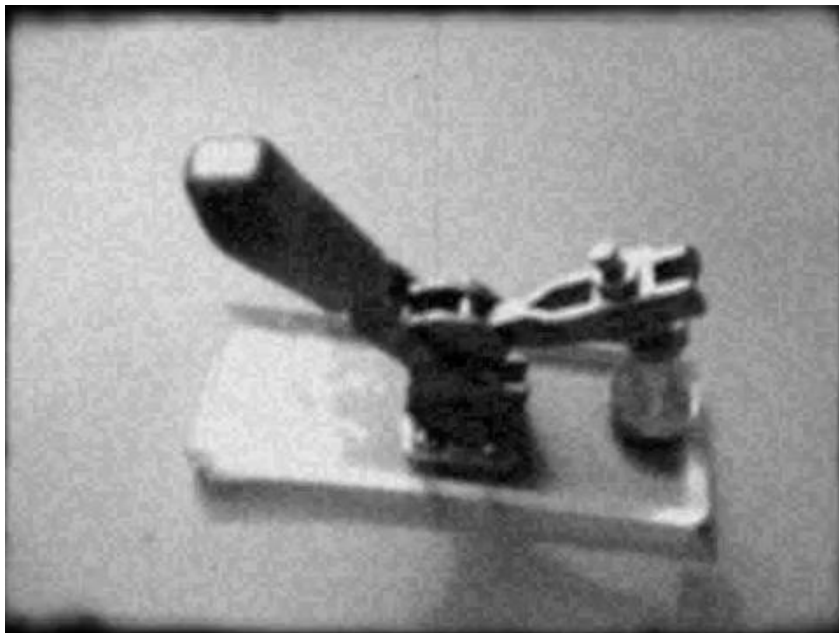

PRESENTAZIONE EFFICACE CON X-MEDIA PUBLISHING

eCATALOG
SOLUTIONS

CATALOGO ELETTRONICO
DEI PRODOTTI

Con il catalogo prodotti di CADENAS eCATALOGsolutions,
investite in una soluzione che cresce con le vostre richieste.

CREIAMO IL VOSTRO CATALOGO PRODOTTI CAD 3D IN QUALSIASI
FORMATO DI DIVULGAZIONE IN CUI LO DESIDERATE!

Il sistema modulare creato
con eCATALOGsolutions è
collegato al vostro ambiente
di sistema esistente e vi
consente di creare il vostro
catalogo prodotti CAD nei
diversi tipi di strumenti
mediali, ad esempio in CD-
ROM, via web, via mobile,
in formato PDF o stampato.





Soluzioni adattabili

Il vostro catalogo su WEB, su CD-ROM, in PDF o CARTACEO

eCATALOG SOLUTIONS

CATALOGO ELETTRONICO DEI PRODOTTI

Chiavette USB Cadenas



ca.300 MB Software
+ 50 MB eCatalog





Semplificate la Configurazione dei vostri Prodotti

eCATALOG
SOLUTIONS

CATALOGO ELETTRONICO
DEI PRODOTTI





Niente è impossibile

eCATALOG
SOLUTIONS

CATALOGO ELETTRONICO
DEI PRODOTTI

The screenshot displays the PARTdataManager 8.1.09 interface. The main window is titled 'lego_dreieck-asm-sbl.prj'. It features several panels:

- Konfigurator:** A tree view showing the assembly structure with components like 'P1 (P1)', 'Tabelleneinschränkungen', 'Wertebereichszuweisungen', and 'Bedingungen'.
- Aufbau (frei: 25, Fehler: 0):** A hierarchical tree view of the assembly components, including 'lego_dreieck-asm-clg.asy', 'P1', and various instances of 'S1' and '4'.
- 3D View:** A 3D rendering of a red letter 'L' constructed from LEGO bricks, with a coordinate system (X, Y, Z) overlaid.
- Table:** A table with columns 'IDMR', 'ANZ', 'COL', and 'W'. The first row shows '1', '10', 'ROT', and '270'.
- DOTTY:** A state transition diagram with nodes labeled 'Start', 'P1', 'S1', and 'PLATTE', connected by arrows.

The status bar at the bottom shows the file name 'lego_dreieck-asm-sbl.sbl', the date '19.08.2010', and the user 'Admin | Dev | Del'.



Esempi di Configurazione dei prodotti

eCATALOG
SOLUTIONS

CATALOGO ELETTRONICO
DEI PRODOTTI



MS⁺AUTOMATION[®]
- part of the FlexLink Group

Esempio di Configuratore di prodotto Online/Offline con varianti aperte:

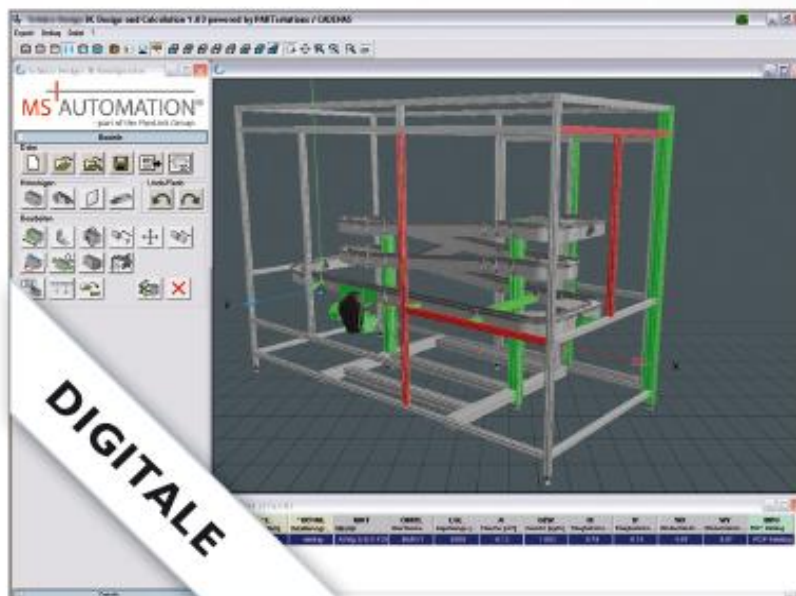

Semplificare prodotti complessi

Configuratore di prodotto

eCATALOG
SOLUTIONS

CATALOGO ELETTRONICO
DEI PRODOTTI

Già dal 2009 la Festo AG offre ai propri clienti un configuratore di prodotto online.

Questo consente la combinazione dei componenti Festo e la successiva esportazione delle geometrie CAD 3D.

I prodotti della Festo possono essere così individuati, adattati alle richieste dei clienti e messi a loro disposizione.

FESTO Esempio di Configuratore di prodotto Online/Offline con varianti chiuse:



DIGITALE



REALE

IMPORTANTE

Con CADENAS non correte il rischio di infrangere diritti di brevetto!

L'utilizzo della configurazione di prodotto con CAD-Automation è protetta dal 12 ottobre 2005 dal Brevetto Europeo EP I 251 444 BI. Il proprietario del brevetto è la FESTO AG & Co. KG (Esslingen). La CADENAS GmbH e i suoi clienti hanno un diritto di utilizzo su questo brevetto.

eCATALOGsolutions – Parti intelligenti

Cosa rende un componente intelligente?

Cinematica-Informazioni sulla movimentazione

Simboli e caratteristiche per gli schemi elettrici e idraulici

Grado di dettaglio per la costruzione di macchinari e impianti

Lunghezza /profondità del filetto e altre importanti misure di collegamento

Data di cessazione – Sostituzione con componente

Struttura

Peso

Informazioni per la documentazione tecnica

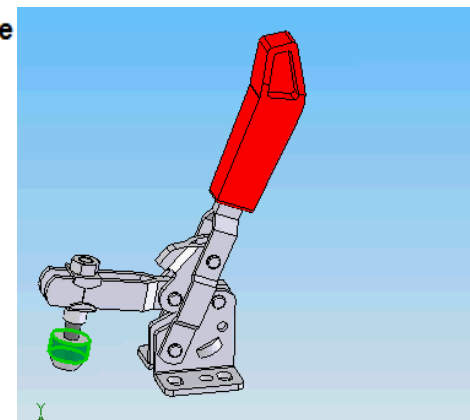
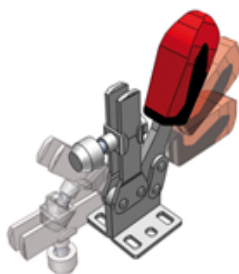

Colore

Spessore

Materiale

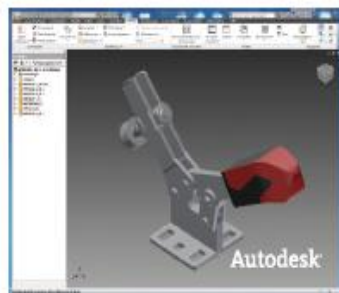
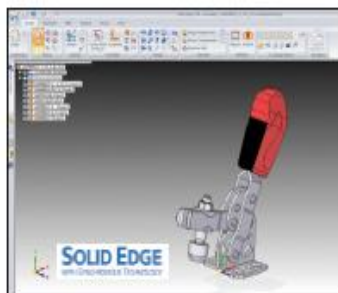

Programmi CAD supportati

Autodesk Inventor	AutoCAD	NX	SOLID EDGE	SOLIDWORKS
CATIA	Allplan	CREO PTC Product	MapasCAD	TopSolid
vero	CimatronE	AVEVA	ZUKEN	ZWCAD
e molti altri programmi CAD				

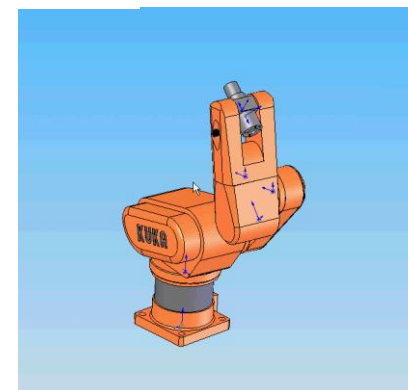

CADENAS: SMART su tutti i sistemi CAD!

eCATALOG
SOLUTIONS

CATALOGO ELETTRONICO
DEI PRODOTTI





Il corporate design ha molte facce

eCATALOG
SOLUTIONS

**CATALOGO ELETTRONICO
DEI PRODOTTI**



Integrazione del portale 3D nel Corporate Design

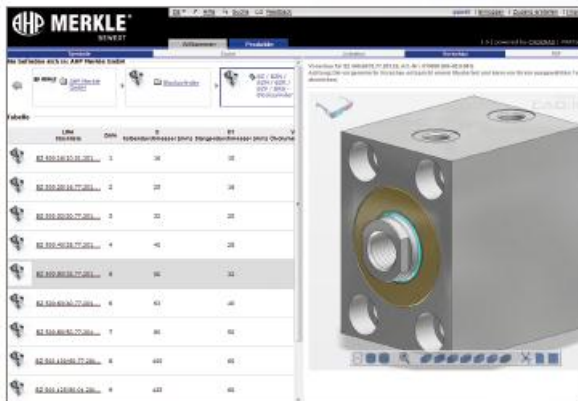

PORTALE CAD 3D

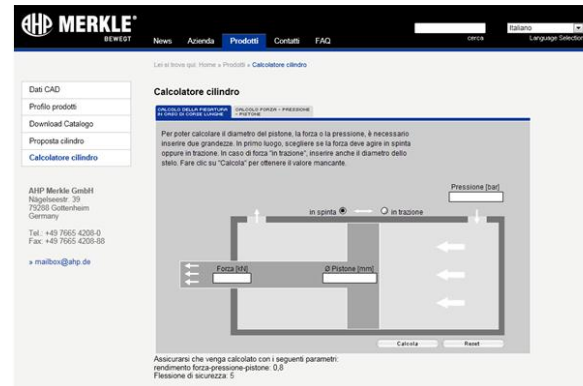

ASSISTENTE



PAGINA WEB CLIENTE

Con CADENAS eCATALOGsolutions il vostro Corporate Design viene mantenuto conforme alle vostre direttive. In qualsiasi modo vogliate presentarvi ai vostri clienti, noi accettiamo la sfida.



Integrazione del portale 3D nel Corporate Design

eCATALOG SOLUTIONS

DER ELEKTRONISCHE PRODUKTKATALOG

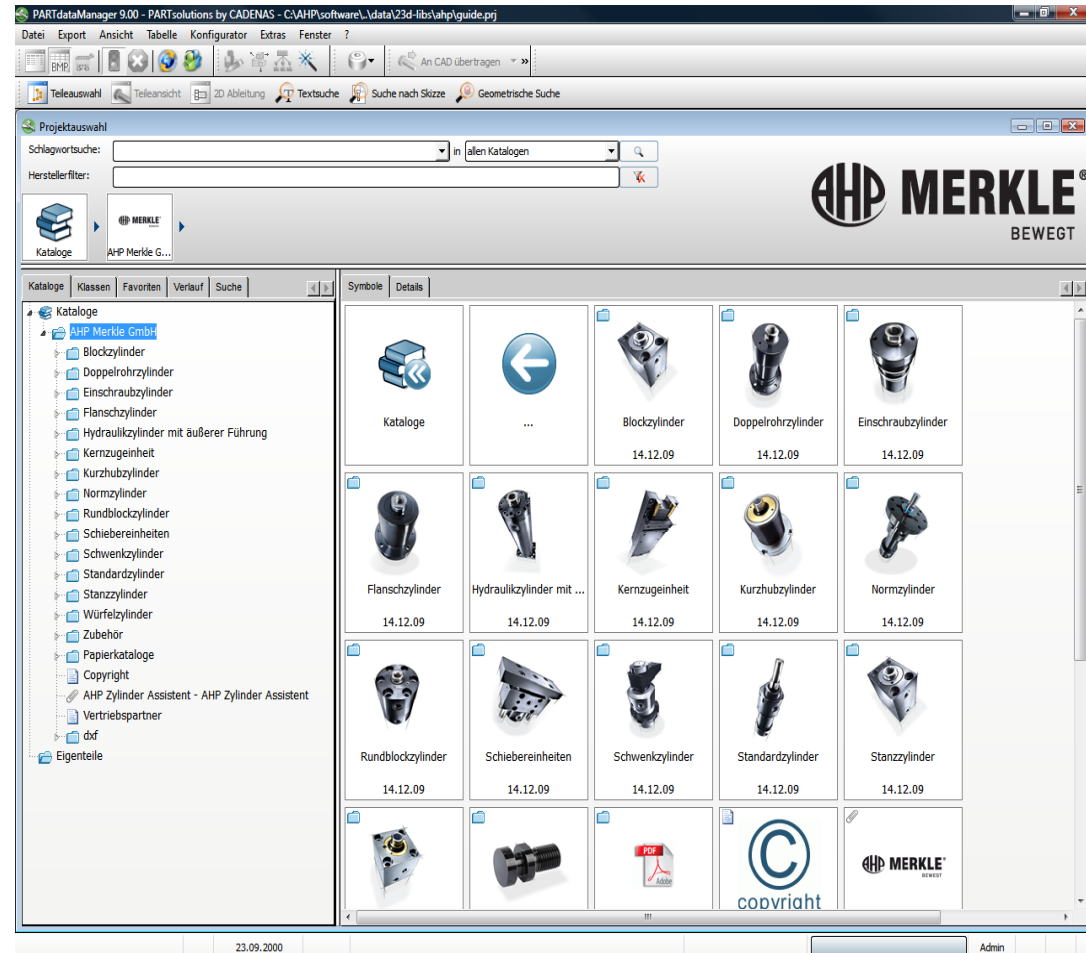
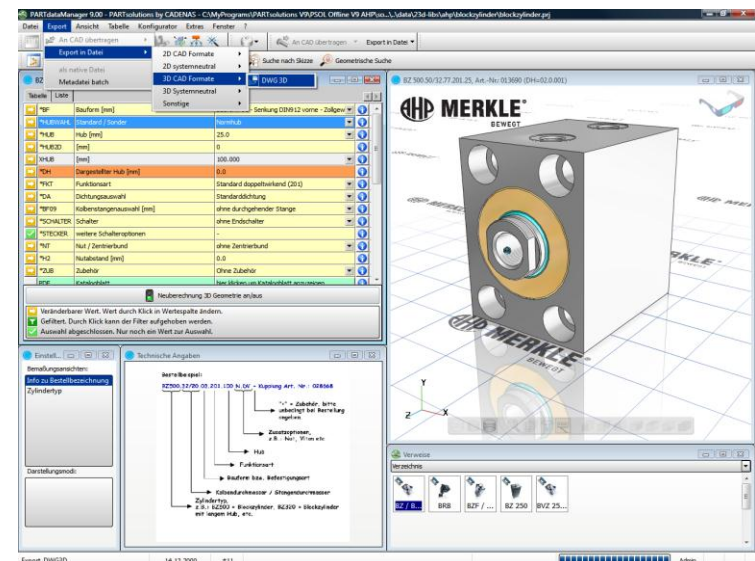
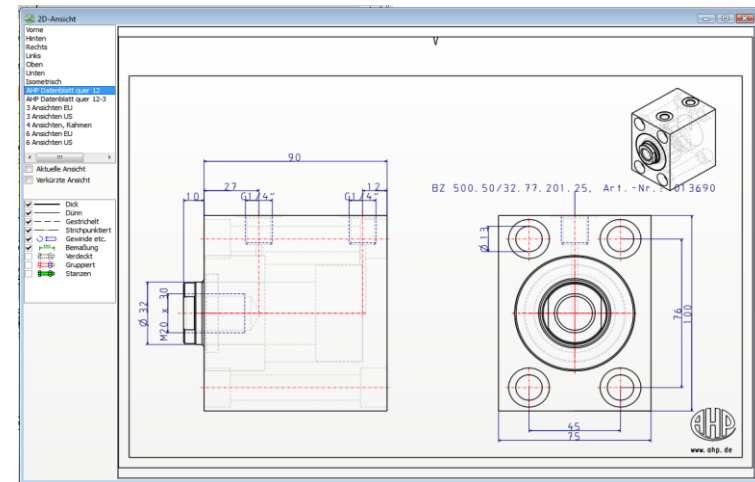

Integrazione del portale 3D nel Corporate Design

eCATALOG
SOLUTIONS

DER ELEKTRONISCHE
PRODUKTKATALOG

FESTO

Festo Product Configurator - Offline Version 2.0.0 / 2003

Konfiguration 163462 NORMZYLINDER DNC-100- -

Produktspezifikation Konfigurationsübersicht

Bestellcode 1 DNC-100-200-PPV-A-Q-S2-KP-V5

Bestellcode 2

Alles ▾

- DNC Antriebsfunktion
- 100 Kolbendurchmesser
- 200 Hublänge mm
- PPV Dämpfungsart
- A Abfrage
- Q Verdrehsicherung
- S2 Kolbenstangenart
- Aussengewinde verlängert
- Innengewinde
- Sondergewinde
- Kolbenstange verlängert
- KP Feststelleinheit
- V5 **Ventil am Zylinder montiert**



Ventil am Zylinder montiert

- V1 Monostabiles Ventil, rechts
- V2 Monostabiles Ventil, rechts
- V3 Bistabiles Ventil, rechts mc
- V4 Monostabiles Ventil, links r
- V5 Monostabiles Ventil, links r
- V6 Bistabiles Ventil, links mon

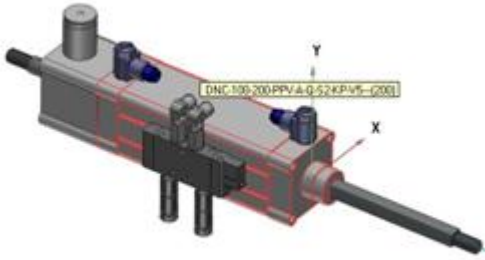

Konfiguration vollständig



Configuratore interattivo

eCATALOG
SOLUTIONS

DER ELEKTRONISCHE
PRODUKTKATALOG

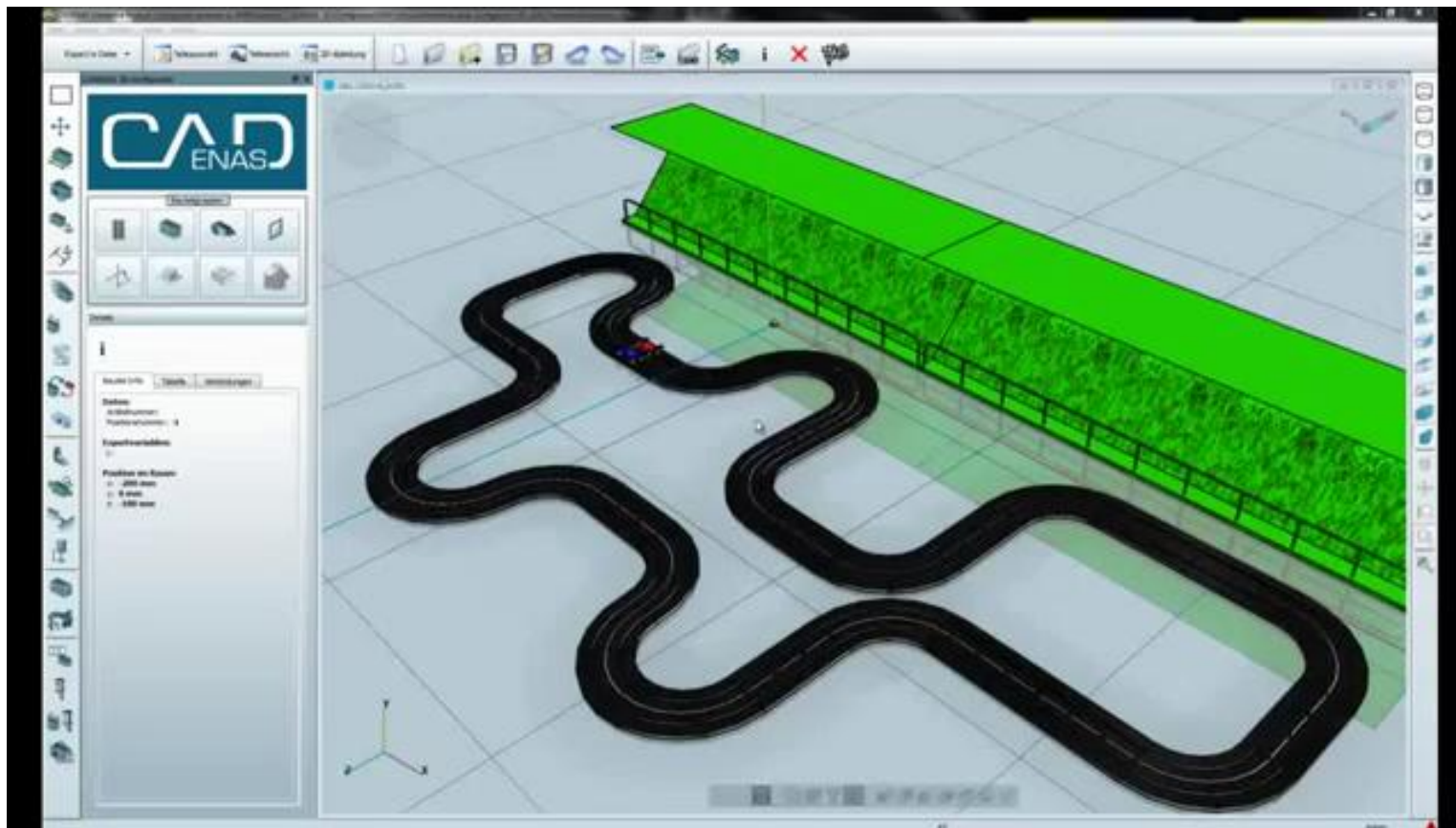

The screenshot displays the PARTdataManager 9.00 BETA software interface. The main window shows a 3D model of a cylinder with several interactive callouts:

- Video of functionality:** A small video player showing a cutaway view of the cylinder's internal mechanism.
- Samples of usage:** A photograph of the cylinder installed in a complex industrial machine, with 'previous' and 'next' navigation buttons.
- Online connection:** A section with a 'Delivery ex-stock' button and a 'more' link, accompanied by a small image of the cylinder and a magnifying glass icon.
- Technical specifications:** A table listing features like 'Special thread' and 'Hollow piston', both marked as 'Yes'.

The interface includes a top menu bar with options like 'Fichier', 'Export', and 'Affichage'. A toolbar at the bottom contains icons for various functions, and a status bar at the very bottom shows the date '27.04.2000', a user ID '#182', and a 'Admin' button.



Innovazione CADENAS nella Tecnologia Web

eCATALOG SOLUTIONS

CATALOGO ELETTRONICO DEI PRODOTTI

Vista 3D

L'anteprima dei modelli CAD 3D può avere diverse viste. Oltre alla vista linee, gli ingegneri hanno a disposizione anche una vista angolo, una vista esploso e una rappresentazione rosso/ciano per la vista 3D.

Ricerca geometrica in 3D

Attraverso il caricamento di una parte CAD disponibile è possibile ricercare componenti simili all'interno di un catalogo.

Ricerca con schizzo 2D

Con l'aiuto dello strumento schizzo è possibile tracciare un semplice disegno 2D di una parte e poi cercarne una simile nei cataloghi elettronici.

Nuovi contatti

Mettete a disposizione dei visitatori del vostro portale il contatto del vostro rivenditore più vicino.

afag

Welcome CAD models

Log in Register Activate Activation Mail Password ? Feedback

Navigation: Home, QA test, Language

Actions: Generate preview, Generate CAD model, Generate PDF datasheet, Download generated CAD models, Request for quotation

Variables

Name	Description	Value
BIB	Bestellnummer	11001000
TYP	Typ	RUZ16
DIV	Druckwinkel	90 deg 0.0 100.0
HUB	Hub	0 mm 0.0 0.0

Actions: Generate preview, Generate CAD model, Generate PDF datasheet, Download generated CAD models, Request for quotation

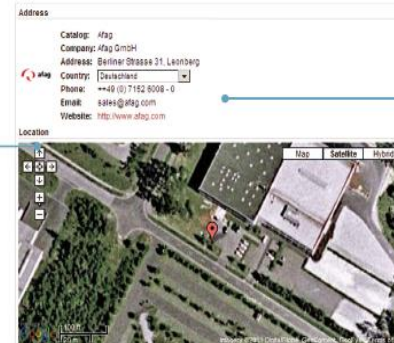
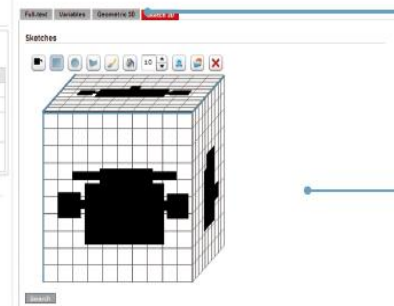

Google Gadgets & Feeds

Il portale download CAD vi offre la possibilità di integrare Google Gadgets (calendario eventi, etc.) e le vostre news aziendali come feeds.



Ricerca di informazioni testuale

eCATALOG SOLUTIONS

CATALOGO ELETTRONICO DEI PRODOTTI

The screenshot shows the PART 2.0 website interface. At the top, there's a navigation bar with 'MODELLI CAD', 'Per i produttori', and 'Aiuto'. A large banner advertises 'Risparmiare Tempo + 2% Sconto* = MISUMI e-Commerce'. Below this, there's a search section titled 'Ricerca modelli CAD' with tabs for 'Testo completo', 'Variabili', 'Geometria 3D', and 'Disegno 2D'. The search criteria are set to 'Tutti i cataloghi' and the search text is 'cilindro idraulico'. Below the search bar, there's a section for 'Anteprima modello CAD' with tabs for 'Anteprima', 'Animazione', 'Diagramma dimensioni', and '3D-PDF'. The main content area shows a list of search results for 'cilindro idraulico'.

Risultati ricerca per cilindro idraulico

Trovato nulla?

Filtra per catalogo:

Tutti i cataloghi 41 / 41 visite

Ridefinire la ricerca

	DADO PER STELO - MOD. S Metalwork
	Cilindro idraulico a guida esterna AHP Merkle
	Freno idraulico serie "brk" per cilindro iso 15552 (ex iso 6431) O 40÷80 mm Metalwork
	GIUNTO SNODATO - MOD. GA-K Metalwork
	RB - Deceleratore idraulico smc
	CERNIERA MASCHIO - MOD. BA Metalwork
	MXS-BS L Corsore - Deceleratore idraulico del corpo del lato d'estensione

	FORCELLA MOD. GK-M Metalwork
	MXS-BS L Corsore - Deceleratore idraulico del corpo del lato d'estensione smc
	CHSD - Cilindro idraulico (comforme ISO) : 10 MPa smc

Navigation: << < 1 2 3 4 5 >> >>>

<< indietro



Ricerca di informazioni schizzo

Ricerca modelli CAD

Testo completo Variabili Geometria 3D Disegno 2D

Catalogo

Ganter

Disegni

Cerca

Ricerca modelli CAD

Testo completo Variabili Geometria 3D Disegno 2D

Risultati ricerca per Cerca schizzi 2D

Trovato nulla?

100 visite

	83%	GN 509.3 - Krallenfederringe Ganter
	80%	DIN 950 F - Handräder mit Vierkant, mit festem Griff Ganter
	80%	DIN 177.4 - Halterohre Ganter
	80%	DIN 950 - Handräder mit Vierkant, mit drehbarem Griff Ganter
	80%	DIN 950 - Handräder ohne Nabennut, mit festem Griff Ganter
	80%	DIN 950 - Handräder mit Nabennut, mit festem Griff Ganter
	80%	DIN 950 - Handräder mit Nabennut, mit drehbarem Griff Ganter
	80%	DIN 950 - Handräder ohne Nabennut, mit drehbarem Griff Ganter
	80%	GN 292 - Edelstahl-Lineareinheiten, Form RL1, mit Rechts- und Ganter
	80%	GN 292 - Lineareinheiten, Form RL1, mit Rechts- und Linksge Ganter

<< 1 2 3 4 5 6 7 >>

<< indietro

Ricerca di informazioni geometrica 3D

eCATALOG
SOLUTIONS

CATALOGO ELETTRONICO
DEI PRODOTTI

Ricerca modelli CAD

Testo completo Variabili Geometria 3D Disegno 2D

Catalogo

Upload dati campione

+ Seleziona file...

Cerca

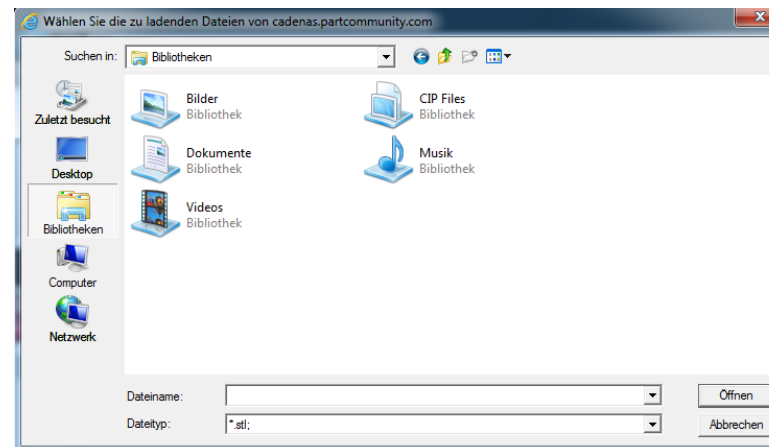

Ricerca di informazioni variabile

Ricerca modelli CAD

Testo completo Variabili Geometria 3D Disegno 2D

Catalogo

Criteri

Nome	Descrizione	Comparatore	Valore
BS	Mounting Side	= ▾	<input type="text"/>
GR	Housing-Edge length	= ▾	<input type="text"/>
UB	Transmission Ratio	= ▾	<input type="text"/>
TYP	Gearbox type	= ▾	<input type="text"/>
EB	downward-facing side	= ▾	<input type="text"/>
AF	select the design	= ▾	<input type="text"/>
BA	select the model	= ▾	<input type="text"/>
INFO	PDF Info	= ▾	<input type="text"/>

<http://cadenas.partcommunity.com/portal/portal/cadenas>

Der richtige Anschlagpunkt für Ihre Konstruktion: Über 300 Varianten... 0,3t - 200t

RUD

Auswahl CAD MODELLE

Alle Kataloge

Navigation

Zurück Startseite QA Siegel Sprache

Klassifikationen

Alle Kataloge Zertifizierte Kataloge Alle Kategorien Alle Länder Alphabetisch

Kataloge

Filter:

A

A4Hydrauliek	ABB	ABB Control Products
Accurate Inc.	ACE Stoßdämpfer	Afag
Agathon	AHP Merkle	Airtac
Alfa Laval	Alfatec	AMF - ANDREAS MAIER GMBH & CO K
Anderson Instruments	Aoki (Mecha Tech)	Apore
Arnold	Asahi	ASYS TECTON
ATEK Antriebstechnik		

B

Baldor Dodge Reliance	Balluff	Bando
Belden	BENE INOX - Raccords Robinetterie -	BENE INOX - Visserie et boulonnerie
Bilsing Automation	Bimba	Bordignon
Bosch Rexroth	Boteco	Brauer

Suche nach CAD MODELLEN

Volltext Variablen Geometrisch 3D Skizze 2D

Katalog

Alle Kataloge

Suchkriterien

Suchtext: Suchen

Voransicht CAD MODELL

Vorschau Animation Maßbild 3D-PDF

Advertisement

TENTE The World in Motion.

3D	IGES
CAD	VRML
Parts	2D
DXF	DWF
DWG	NX3
STEP	U3D



Mr. Henry Ford

Smettere di fare pubblicità per risparmiare soldi è come fermare l'orologio per risparmiare tempo.

eCATALOG
SOLUTIONS

CATALOGO ELETTRONICO
DEI PRODOTTI

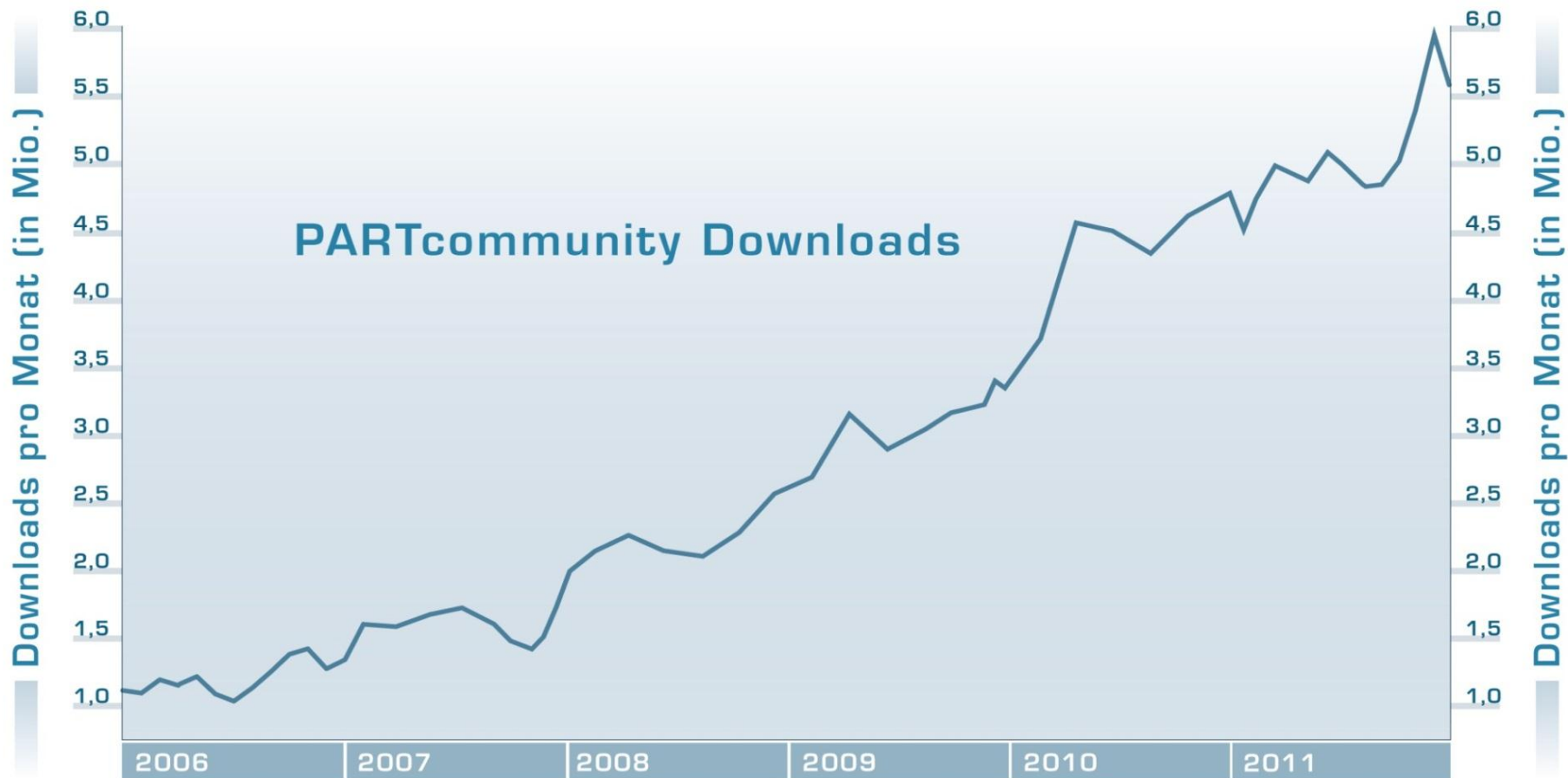

Circa l' **87%** dei **modelli CAD scaricati** porta alla successiva vendita dei prodotti.





Quanto costa un nuovo contatto?

Quanto costa 1 nuovo contatto ?



FIERA



MERCATI VERTICALI BY CADENAS



eCATALOGsolutions – CATALOGO ELETTRONICO DEI PRODOTTI CADENAS!

eCATALOG SOLUTIONS

CATALOGO ELETTRONICO DEI PRODOTTI

Informazioni per l'ufficio vendite!



Vendita, Contatto, Analisi

(Nome, Azienda, Tel, Indirizzo e-mail, Nr. Codice, CAD Format, Tempi...)

La vostra pagina WEB

eCATALOG sul Web

Statistica download

File CAD

Utente finale

Download diretto o invio per posta elettronica

Portale di download CADENAS

0 0 0 3 5 9 7 2 7 2

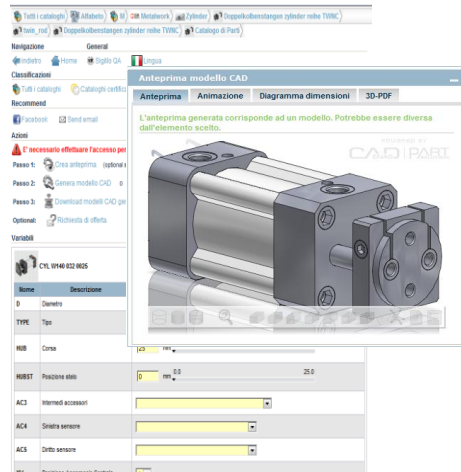
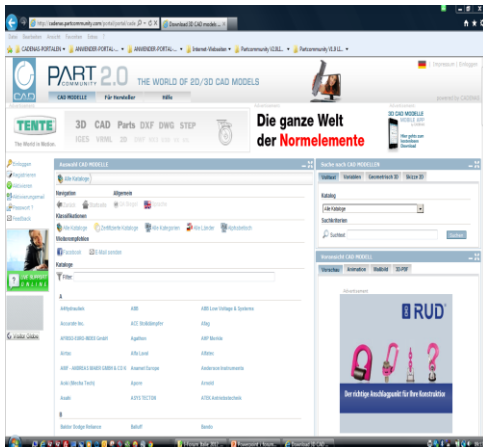
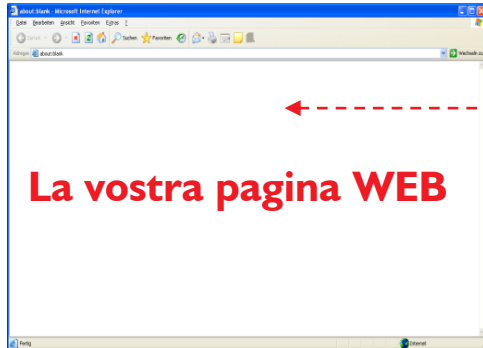
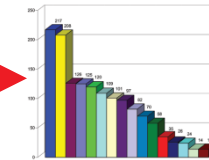



Processi Aziendali ottimizzati PARTstatistics

eCATALOG
SOLUTIONS

CATALOGO ELETTRONICO
DEI PRODOTTI

Gli strumenti di statistica e analisi di CADENAS eCATALOGsolutions rendono i vostri clienti trasparenti.

Controllare i processi interni e aumentare il successo aziendale

La nostra filosofia è quella di non fare statistiche a caso. Noi forniamo analisi e informazioni con un alto valore economico e commerciale.

Richiesta prodotti per nazione

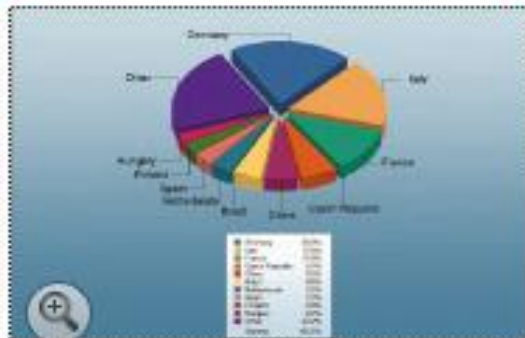

Top 10 prodotti richiesti

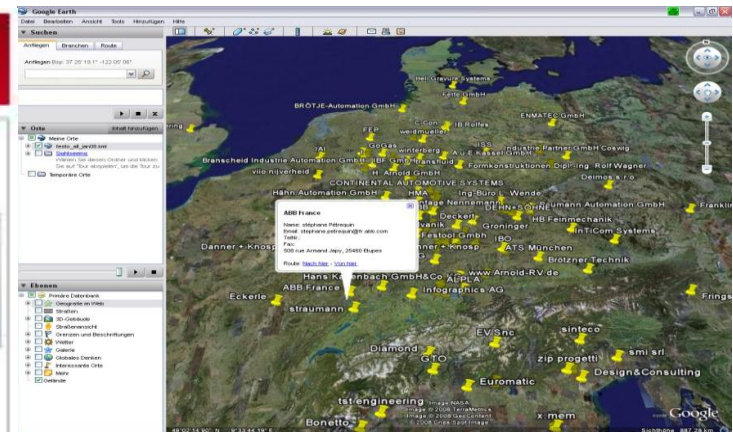
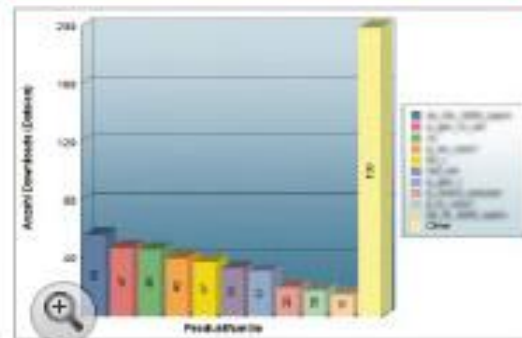

Richieste visualizzate su Google Earth



Tendenza dei prodotti richiesti



Statistica Visitatore Web e mobile



UN MARKETING DI SUCCESSO PER I PRODOTTI

eCATALOG
SOLUTIONS

CATALOGO ELETTRONICO
DEI PRODOTTI

COME MISUMI, UNA REFERENZA COME CLIENTE,
STA OTTENENDO VANTAGGI CON IL CATALOGO
ELETTRONICO DEI PRODOTTI DI CADENAS



Fornitura di
1.125.000

Modelli CAD al mese
a cliente MISUMI
in tutto il mondo

di qui
l'87 %
porta alla
vendita dei
prodotti

\$ 460 milioni
di vendite all'anno
dalla piattaforma web



Crescita del 49 %
di modelli CAD scaricati
con l'implementazione
del Catalogo Elettronico
di CADENAS



67 formati CAD
assicurano la massima
soddisfazione del
cliente



3.450
pagine di prodotti
nel catalogo cartaceo MISUMI



Esistono
97 miliardi
di combinazioni
per ogni pagina doppia

Il Catalogo Elettronico
dei prodotti è disponibile
in **10 lingue!**





SmartDevices e APPs

Pronti per il futuro con il Mobile Marketing

eCATALOG
SOLUTIONS

CATALOGO ELETTRONICO
DEI PRODOTTI



Applicazione mobile per analisi marketing

eCATALOG SOLUTIONS

CATALOGO ELETTRONICO DEI PRODOTTI





Pronti per il futuro con il mobile Marketing

APP eCATALOGsolutions!

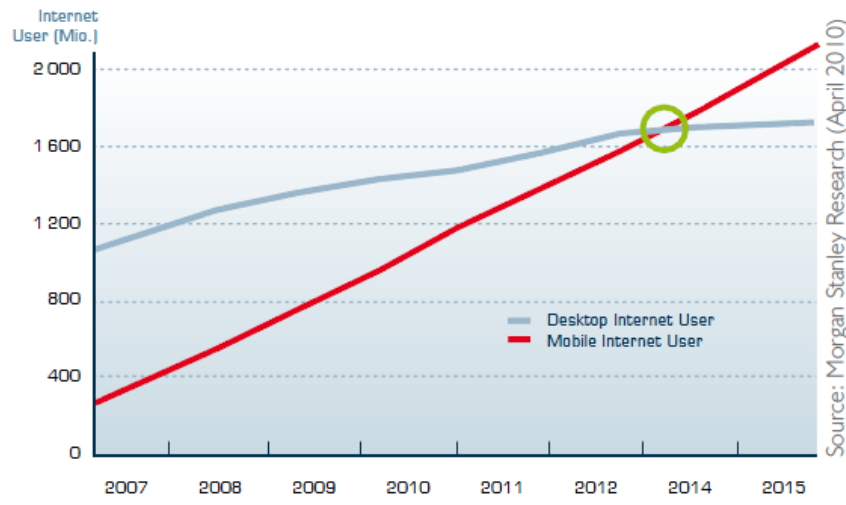



Pronti per il futuro con il mobile Marketing

eCATALOG
SOLUTIONS

CATALOGO ELETTRONICO
DEI PRODOTTI

APP eCATALOGsolutions!

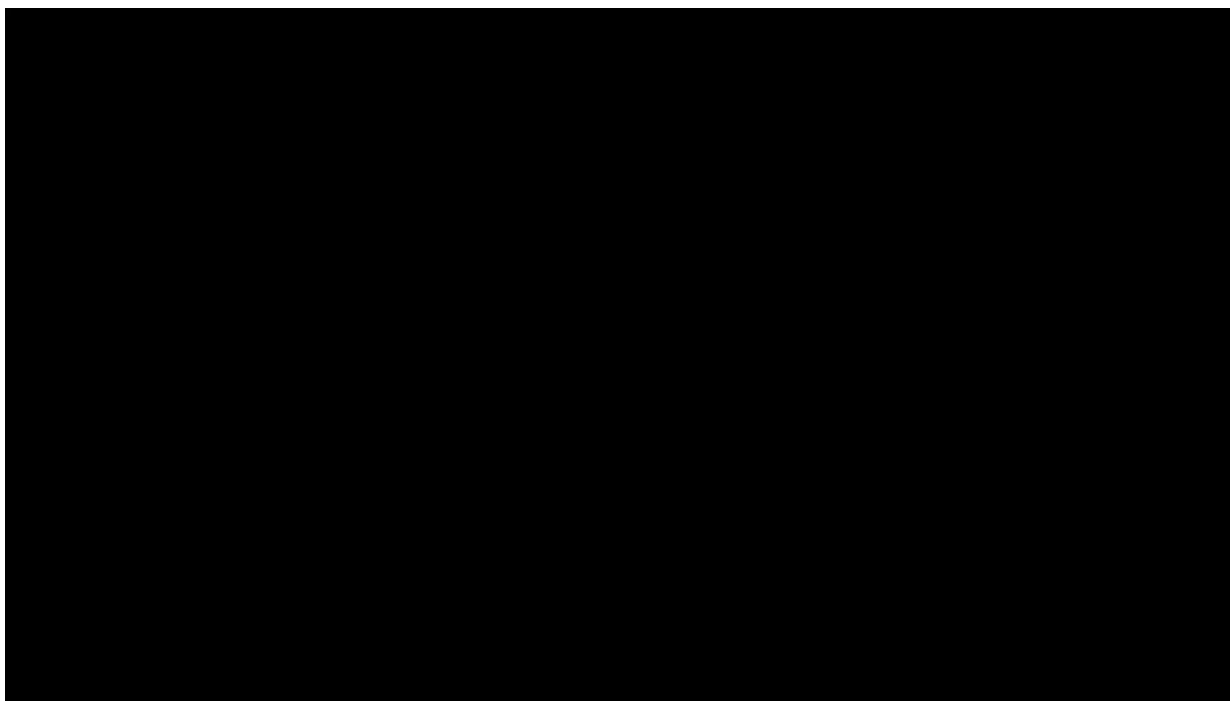

eCATALOGsolutions APP - APP per i vostri clienti

eCATALOG
SOLUTIONS

CATALOGO ELETTRONICO
DEI PRODOTTI



Configuratore di prodotto
Configurare correttamente
componenti e creare la
relativa geometria CAD 3D



Ricerca tramite schizzo
Trovare componenti con
uno schizzo 2D



Informazioni sui prodotti
Dettagli e immagini
dei singoli componenti



Modelli CAD 3D
Navigazione nei cataloghi



Ricerca prodotto per testo
Motore di ricerca per testo
con supporto di lingue straniere
e proposte di parole di ricerca
alternative



Richiesta offerta
Richiesta di offerte
non impegnative



Come acquistare
Indirizzi e contatti
degli uffici vendite



News
Informazioni aggiornate su
aziende e prodotti



eShop
Ordinare componenti
direttamente online



Supporto
Richieste
su prodotti e
aziende



I vostri clienti e concorrenti saranno stupiti!



Attirare l'attenzione tramite Occhiali 3D



Per presentare i vostri prodotti non solo a livello informativo ma anche creando una forte attrattiva, date ai visitatori del vostro stand gli occhiali 3D. Immagini reali, quasi tangibili, dei vostri componenti sorprenderanno i vostri visitatori. Come gadget da regalare, gli **occhiali 3D** con il vostro nome e indirizzo internet sono un ottimo strumento per far trovare il vostro catalogo dei prodotti in internet anche dopo la fiera.





Affascinare con le informazioni Occhiali 3D

eCATALOG
SOLUTIONS

CATALOGO ELETTRONICO
DEI PRODOTTI



<http://go.partsolutions.com/3d-glasses>

no 3D glasses?



I WANT IN ON THE FUN!

fill out the form and we will send you **FREE** pair right away

Creare un ponte tra il cartaceo e il digitale

I comuni depliant pubblicitari dei prodotti ormai raramente destano interesse. Per questo dovreste conquistare i vostri visitatori in fiera con l'innovativo flyer dei prodotti con Augmented Reality, che fa entrare tutti nel mondo della realtà virtuale. Realizzato con i necessari marker, il vostro depliant sorprenderà con i modelli CAD 3D visibili grazie alla tecnologia Augmented Reality.

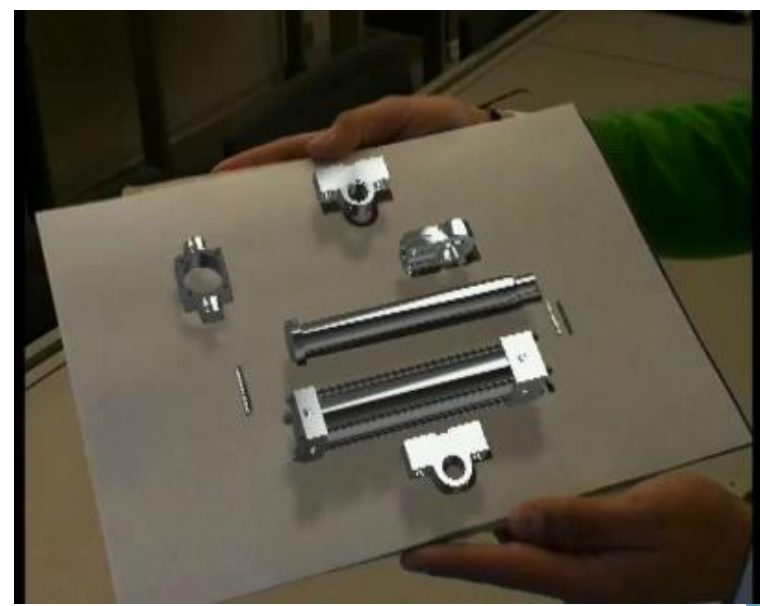
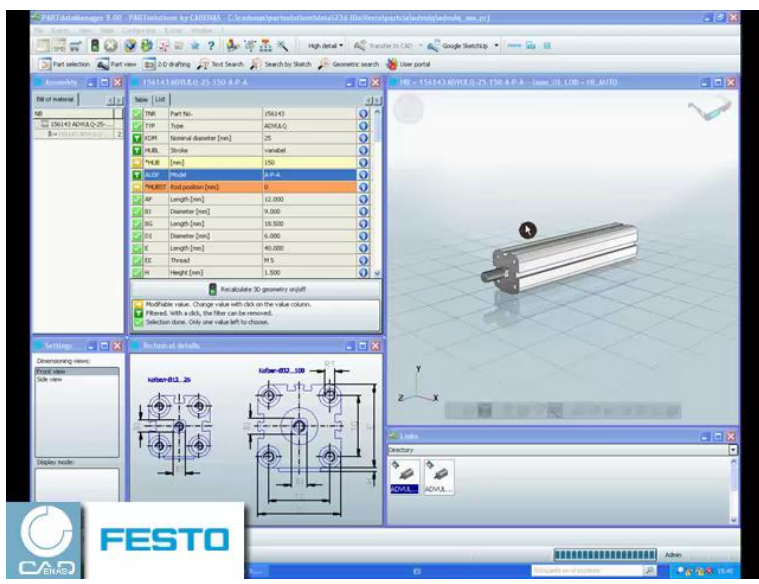
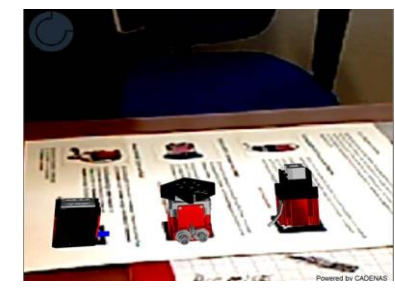



L'innovazione per avere più attenzione in fiera

eCATALOG
SOLUTIONS

CATALOGO ELETTRONICO
DEI PRODOTTI

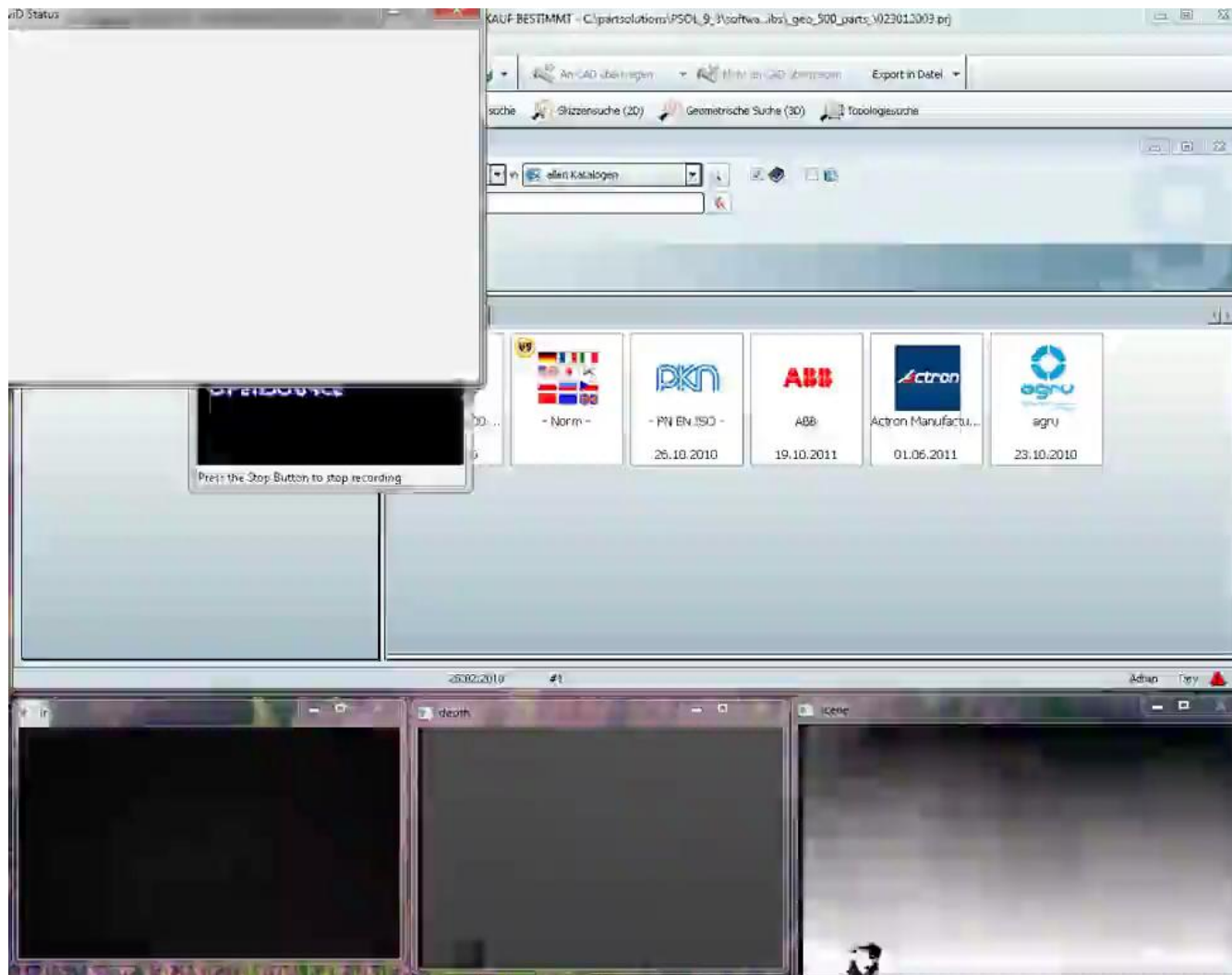

KINECT
for XBOX 360



Giocando con il telecomando Wii il vostro catalogo dei prodotti diventa protagonista sulla scena



Con il telecomando Wii il controllo e il movimento delle parti del catalogo prodotti elettronico è un gioco da bambini. Con questa ulteriore funzione di eCATALOG di CADENAS portate il vostro catalogo prodotti al centro dell'attenzione dei vostri clienti. Soprattutto in fiera questa innovazione di CADENAS diventa un'attrattiva per i visitatori, in quanto li spinge a fermarsi, a partecipare e a trattenersi più a lungo presso il vostro stand.



Ricerca mobile

Follow-up immediato

Probabilmente siete già riusciti ad intrattenere i vostri visitatori in fiera. Per assicurarvi che questi visitatori si ricordino dei vostri prodotti, mostrategli come sia facile entrare nel vostro catalogo digitale di parti CAD 3D. Con il **Quick Response Code** sui vostri prodotti e uno smartphone, i visitatori possono facilmente trovare e accedere ai vostri componenti. Richiedendo un loro biglietto da visita o l'indirizzo e-mail potete inviare il link del vostro catalogo elettronico dei prodotti, come risultato della ricerca mobile, direttamente all'indirizzo e-mail dei visitatori interessati.



Risparmiare il fotografo!

La nuova interfaccia eCATALOGsolutions consente di realizzare immagini dei prodotti semplicemente cliccando un tasto

Risultato

PARTdatamanager

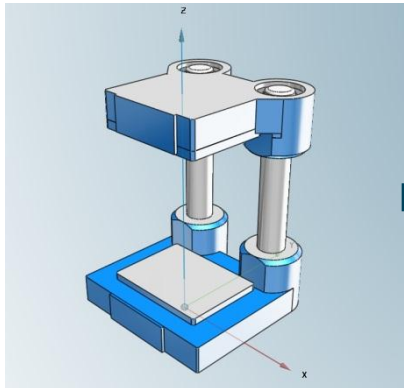

Configurazione

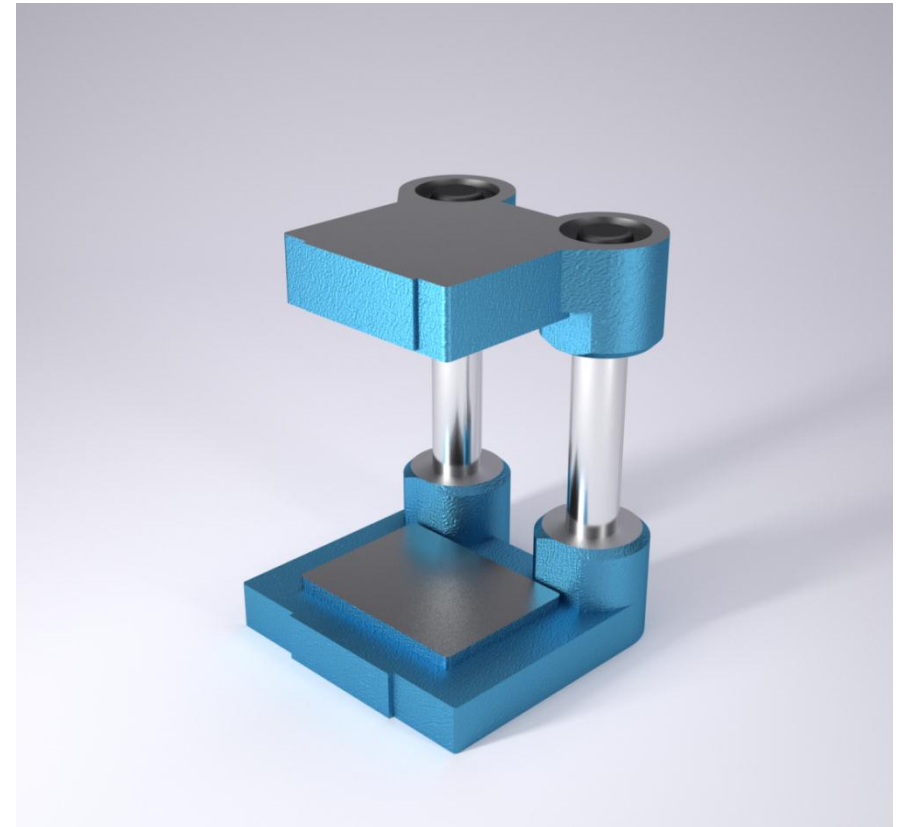
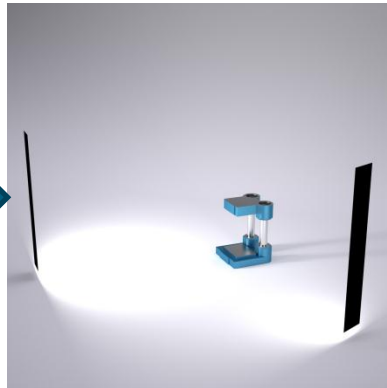

Risparmiare il fotografo!

eCATALOG
SOLUTIONS

CATALOGO ELETTRONICO
DEI PRODOTTI

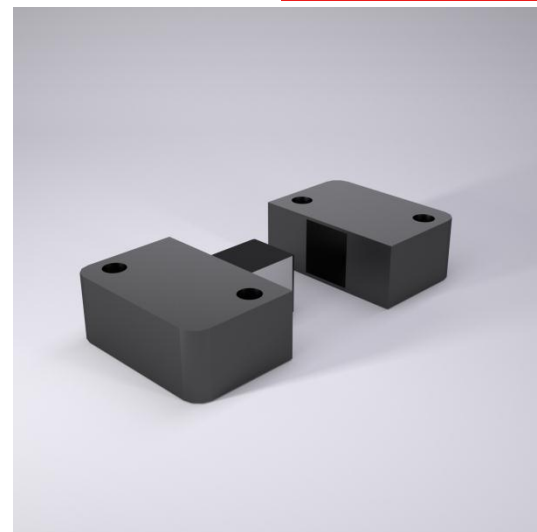

Il catalogo cartaceo diventa Moderno

eCATALOG
SOLUTIONS

CATALOGO ELETTRONICO
DEI PRODOTTI



Oltre a contenere le informazioni tecniche classiche dei prodotti, il catalogo cartaceo di CADENAS può essere ampliato con molte funzioni innovative:



I vantaggi per il vostro catalogo cartaceo
„Un database centrale e quindi utilizzo dei dati per tutti i formati

„La manutenzione dei dati è necessaria solo su un unico archivio centrale

„Eliminazione di eventuali fonti di errori aggiuntivi

„Creazione veloce di diversi cataloghi in diverse lingue

„Collegamento tra catalogo cartaceo e catalogo online

„Supporto di Adobe Indesign e QuarkXPress

eCATALOG solutions- modulo stampa con ASIM GMBH

eCATALOG
SOLUTIONS

CATALOGO ELETTRONICO
DEI PRODOTTI

100% Riutilizzo dei dati

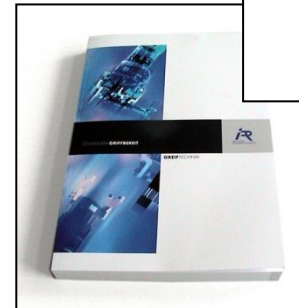

eCATALOGsolutions- modulo stampa con ASIM GMBH

eCATALOG
SOLUTIONS

CATALOGO ELETTRONICO
DEI PRODOTTI

Come creare un PDF-3D dai nostri modelli cad.

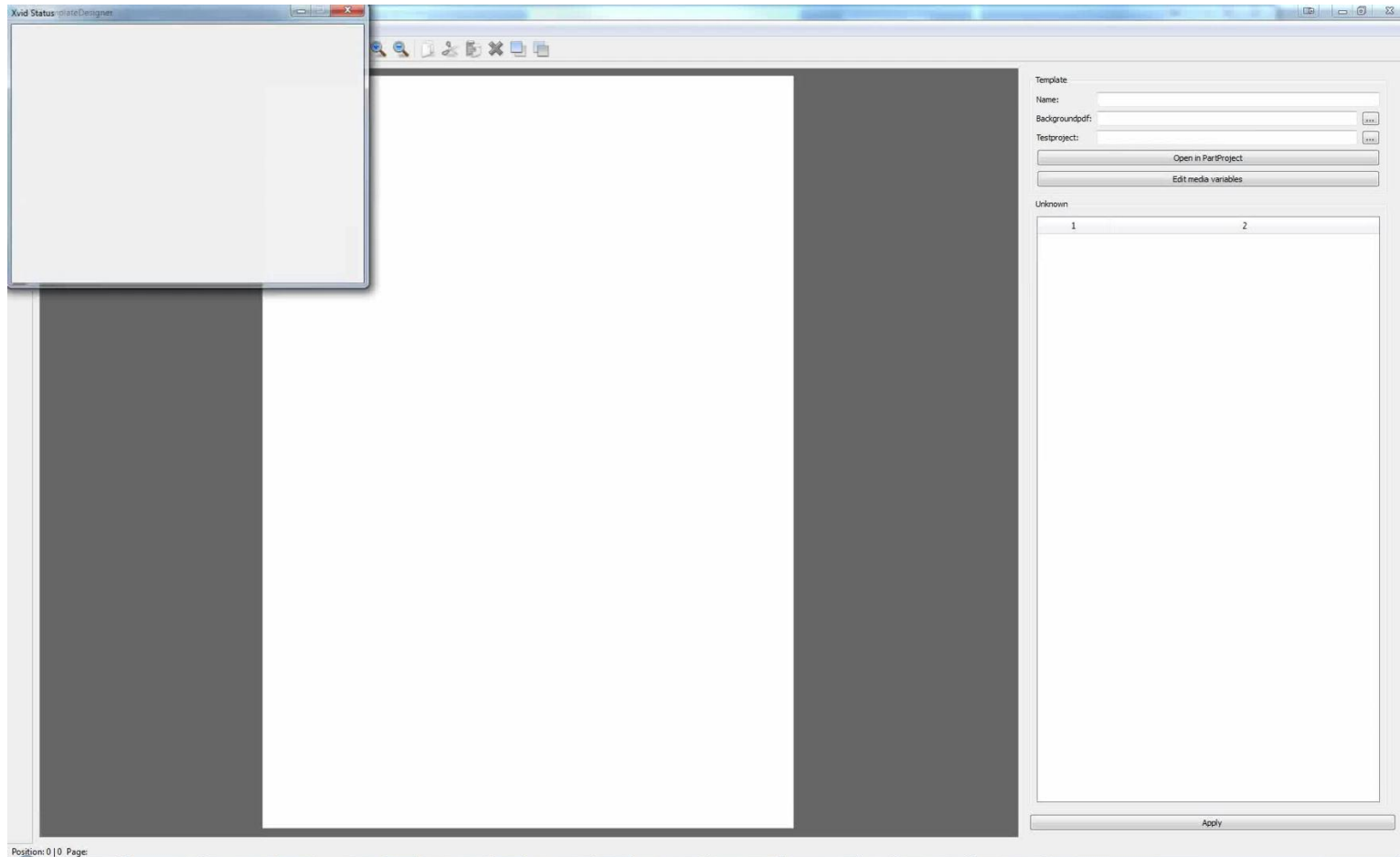



Schede dati 3D in PDF

Con eCATALOGsolutions è possibile generare schede dati 3D in formato PDF direttamente dal vostro Catalogo Elettronico CAD.

The image displays six 3D data sheets (PDFs) arranged in a 2x3 grid. Each sheet is a technical document for a specific product, featuring a red header with the manufacturer's name, product images, technical drawings, and a table of specifications.

- HÜLSEN:** Shows various types of bearings and rollers with technical drawings and a table of dimensions.
- Mader:** Displays different models of bearings and rollers, including a large red roller, with technical drawings and a table of specifications.
- PHD Inc.:** Features a green roller with a yellow shaft, technical drawings, and a table of specifications.
- MAN Diesel & Turbo:** Shows a large industrial engine component with technical drawings and a table of specifications.
- Zimmer:** Displays a grey roller with a black shaft, technical drawings, and a table of specifications.
- Sheffer Corp.:** Shows a grey roller with a black shaft, technical drawings, and a table of specifications.



V9 Features VIDEO

eCATALOG
SOLUTIONS

CATALOGO ELETTRONICO
DEI PRODOTTI

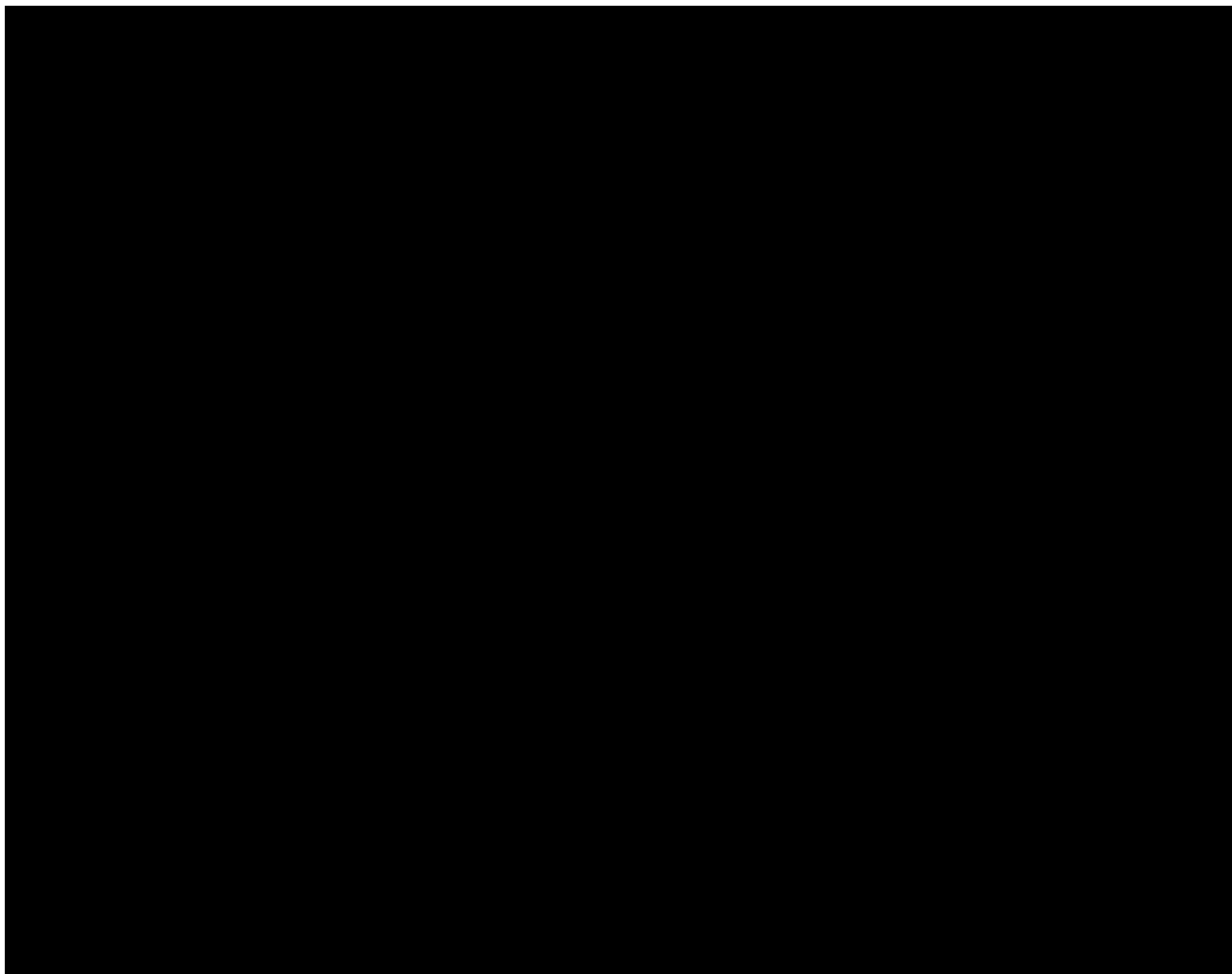



Grazie per l'attenzione

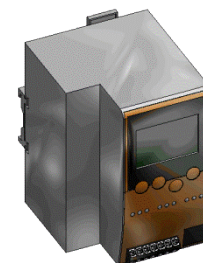
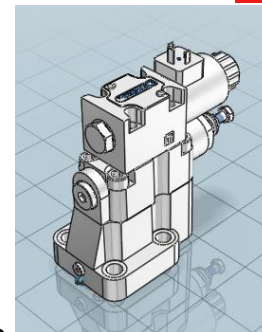
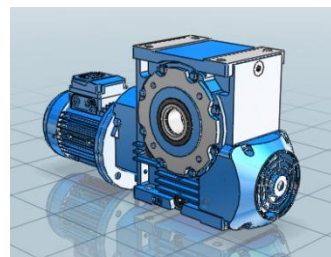
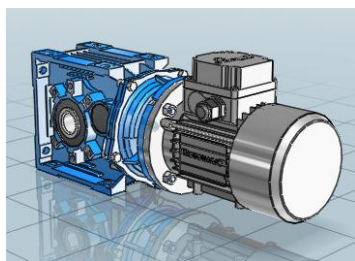
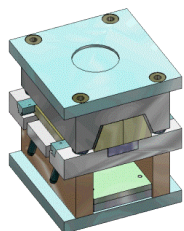
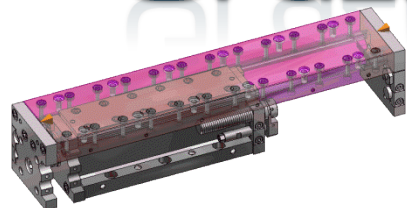

DOMANDE?

FEEDBACK?

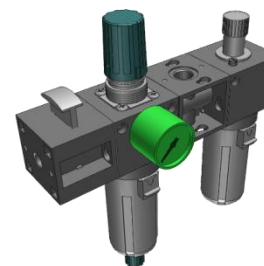
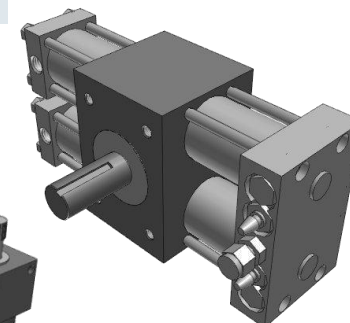

Giorgio Clari
 Project Management Germania , Italia

Phone.: +49 (0) 821 2 58 58 0 - 0
 E-Mail: G.Clari@cadenas.de

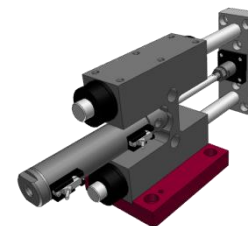

This document and all therein contained information are the sole property of CADENAS AG. The delivery of this documentation or the publication of its contents is considered plagiarism. This document may not be multiplied or displayed to a third party without the exclusive written approval of CADENAS AG. This document and its contents may only be used in accordance with certain purposes.

The information given in this document are not considered an offer. It was made on the basis of the assumptions listed and in good faith. If the reasons associated with these statements are not clear, please contact CADENAS AG in order to further clarify the basic principles.